

Tanaka Illustrated Parts Manual

Model Number:

TPH-250PF

POLE HEDGETRIMMER

P/N 30773

Rev 000

Date 10-24-07



Nikko Tanaka Engineering U.S.A.,Ltd. • 1028 4th Street SW, Bldg B • Auburn, WA 98001 • Phone: (253) 333-1200 • Fax: (253) 333-1212

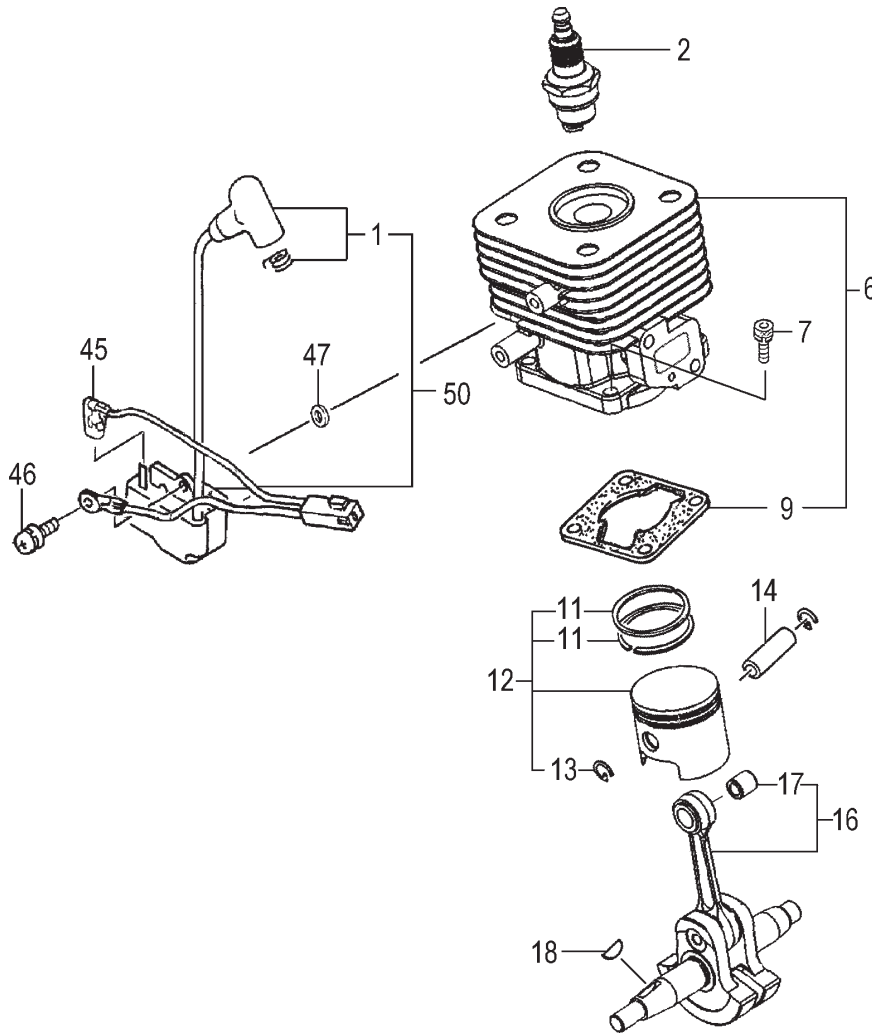

ITEM	PART NUMBER	DESCRIPTION	QTY	COMMENTS
1-1	1570168090	CAP, SPARK PLUG ASS'Y	1	
1-2	0181161021	PLUG, SPARK	1	
1-6	0010304590	CYLINDER, SET	1	Includes cylinder gasket
1-7	99461050184	BOLT, HEX, 5X18, S	4	
1-9	0170300221	GASKET, CYLINDER	1	
1-11	04101601200	RING, PISTON	2	
1-12	0300704590	PISTON SET	1	Includes rings and circlips
1-13	03901620200	CIRCLIP	2	
1-14	0370704520	PIN, PISTON	1	
1-16	0460304581	CRANKSHAFT	1	
1-17	99962081225	BEARING, NEEDLE, F-810	1	
1-18	06810100200	KEY, WOODRUFF, 3X13X4.5	1	
1-45	1910168090	WIRE, LEAD ASS'Y	1	
1-46	99464040184	BOLT, HEX 4x18WS	2	
1-47	1820186A201	WASHER, SPECIAL	2	
1-50	1672101090	COIL, IGNITION	1	

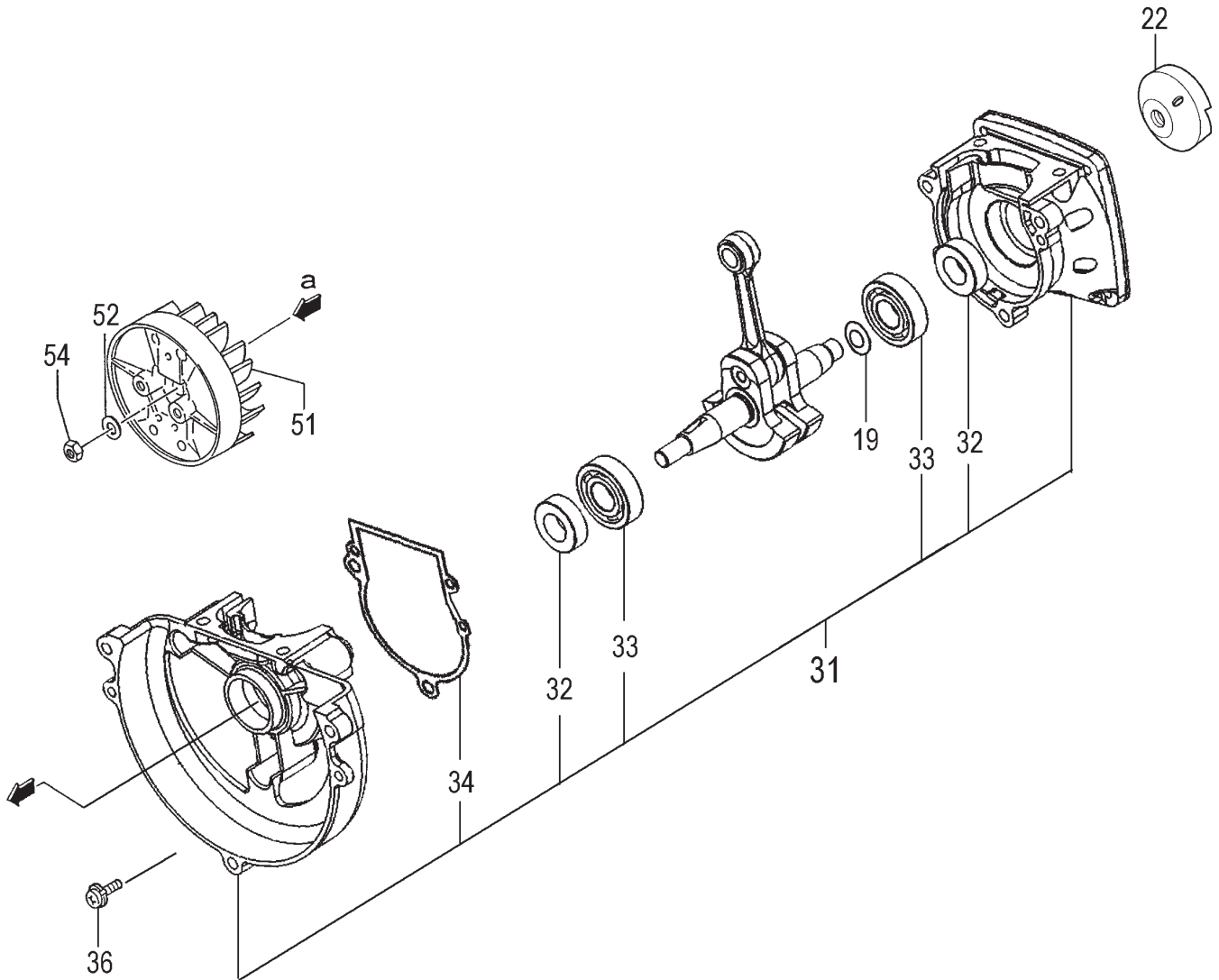

ITEM	PART NUMBER	DESCRIPTION	QTY	COMMENTS
2-19	33000200210	SHIM,12.2X19X.10	V	Shims are "as needed" to obtain correct side clearance
2-19	33000200220	SHIM,12.2X19X.15	V	
2-19	33000200230	SHIM,12.2X19X.20	V	
2-19	33000200240	SHIM,12.2X19X.30	V	
2-22	7980304520	PULLEY,STARTER	1	
2-31	0720304590	CRANKCASE ASSY	1	Includes bearings, seals and gasket
2-32	99966122206	SEAL,OIL,#TC12227	2	
2-33	99961600115	BEARING,BALL,6001 C3	2	
2-34	0900304520	GASKET,CRANKCASE	1	
2-36	99461050164	BOLT,HEX,5X16,S	3	
2-51	1552174380	ROTOR,MAGNETO	1	
2-52	99201070011	WASHER,7	1	
2-54	06600000200	NUT,FLYWHEEL	1	

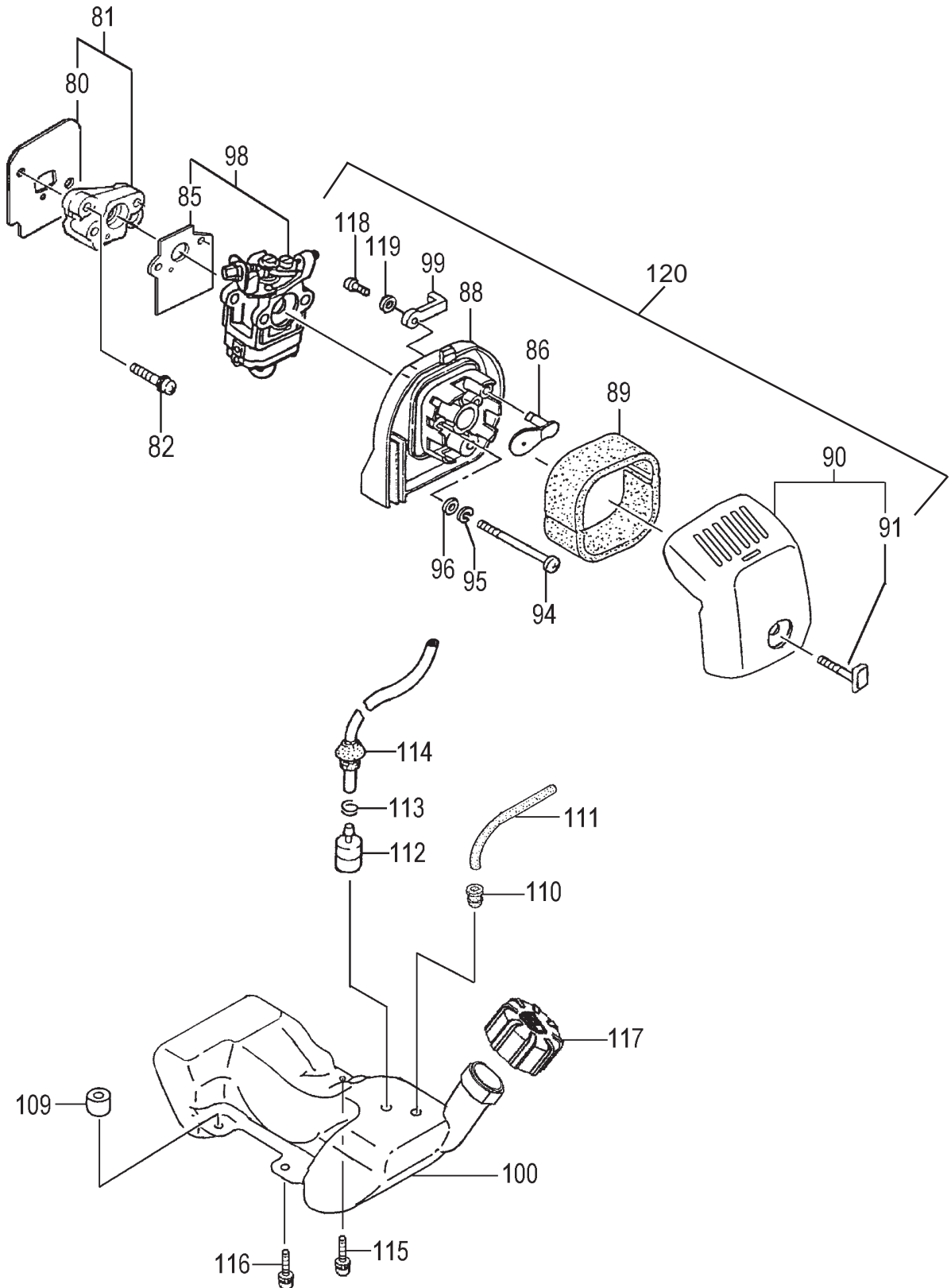

ITEM	PART NUMBER	DESCRIPTION	QTY	COMMENTS
3-80	4030702021	GASKET,INLET MANIFOLD	1	
3-81	4040702091	INSULATOR SET	1	Includes gasket
3-82	99416050241	SCREW 5x24WS	2	
3-85	4020656A200	GASKET	1	
3-86	5280652N22	PLATE,CHOKE,2.0	1	
3-88	4230652N80	BODY,AIR CLEANER	1	
3-89	4460652N20	CLEANER,ELEMENT	1	
3-90	4520304690	COVER,AIR CLEANER ASSY	1	
3-91	4500702480	BOLT,CLEANER COVER	1	
3-94	99011050552	SCREW,5X55	2	
3-95	99210050012	WASHER,S,5	2	
3-96	99200050011	WASHER,SMALL,5	2	
3-98	4550304590	CARBURETOR SET	1	Includes gasket
3-99	4230652N80	BODY,AIR CLEANER	1	
3-100	5910304520	TANK,FUEL	1	
3-109	65900801200	COLLAR	3	
3-110	53432710200	GROMMET,FUEL PIPE	1	
3-111	70003005065	PIPE,FUEL,3X5X65	1	
3-112	6750404280	FILTER,FUEL	1	
3-113	68000731201	CLIP 6.3	1	
3-114	2230162V900	PIPE,FUEL,ASS'Y	1	
3-115	99463050205	BOLT,HEX,5X20PS	1	
3-116	99463050204	BOLT,HEX 5X20	2	
3-117	5950300290	CAP,TANK (BLACK/RED)	1	
3-118	99075040154	SCREW,TAPPING,4X15	1	
3-119	99201040011	WASHER,4	1	
3-120	4100304690	AIR CLEANER ASS'Y	1	

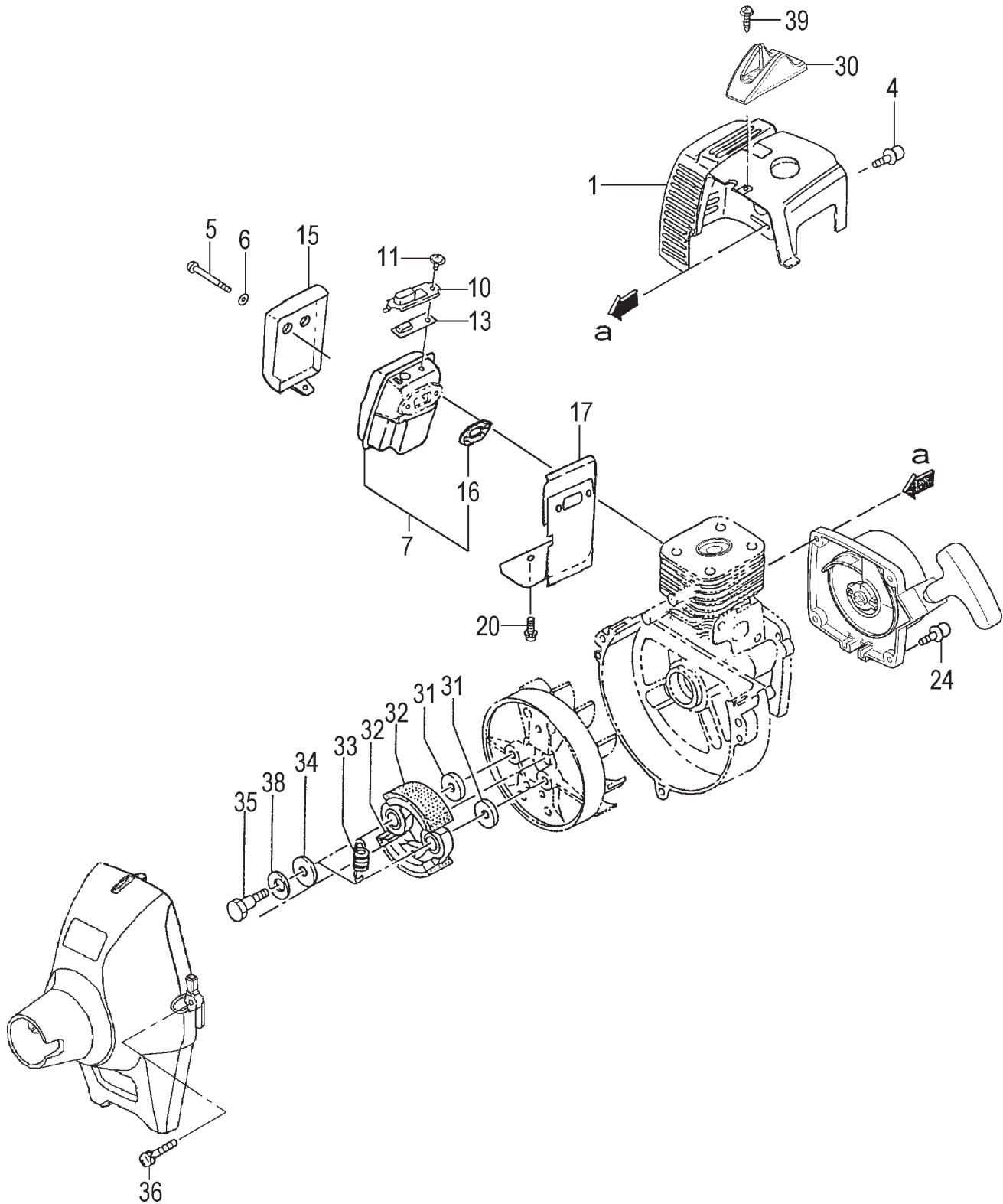

ITEM	PART NUMBER	DESCRIPTION	QTY	COMMENTS
4-1	7380304620	PROTECTOR,MUFFLER	1	
4-4	99415040182	SCREW,PS,4X18	2	
4-5	99053060553	SCREW,HEX.HOLE	2	
4-6	99201060011	WASHER,6	2	
4-7	7040304590	MUFFLER SET	1	
4-10	7210440020	PIPE,TAIL	1	
4-11	99436040081	SCREW,4X18WS	1	
4-13	7320440020	ARRESTER,SPARK	1	
4-15	7360304580	COVER,MUFFLER B	1	
4-16	7370168020	GASKET,MUFFLER	1	
4-17	7350304580	SHIELD,HEAT	1	
4-20	99415050101	SCREW,5X10/PS	1	
4-24	99415040182	SCREW,PS,4X18	2	
4-30	2570304520	PROTECTOR,SPARK PLUG	1	
4-31	35902103200	WASHER,CLUTCH,B	2	
4-32	29001620800	SHOE,CLUTCH	2	
4-33	3420630B200	SPRING,CLUTCH	1	
4-34	3480602R200	WASHER,CLUTCH A	2	
4-35	3570075T200	BOLT,STEP	2	
4-36	99415050202	SCREW,5X20/PS	3	
4-38	99205080030	WASHER,8	2	
4-39	99072045164	SCREW,TAPPING,4.5X16	1	

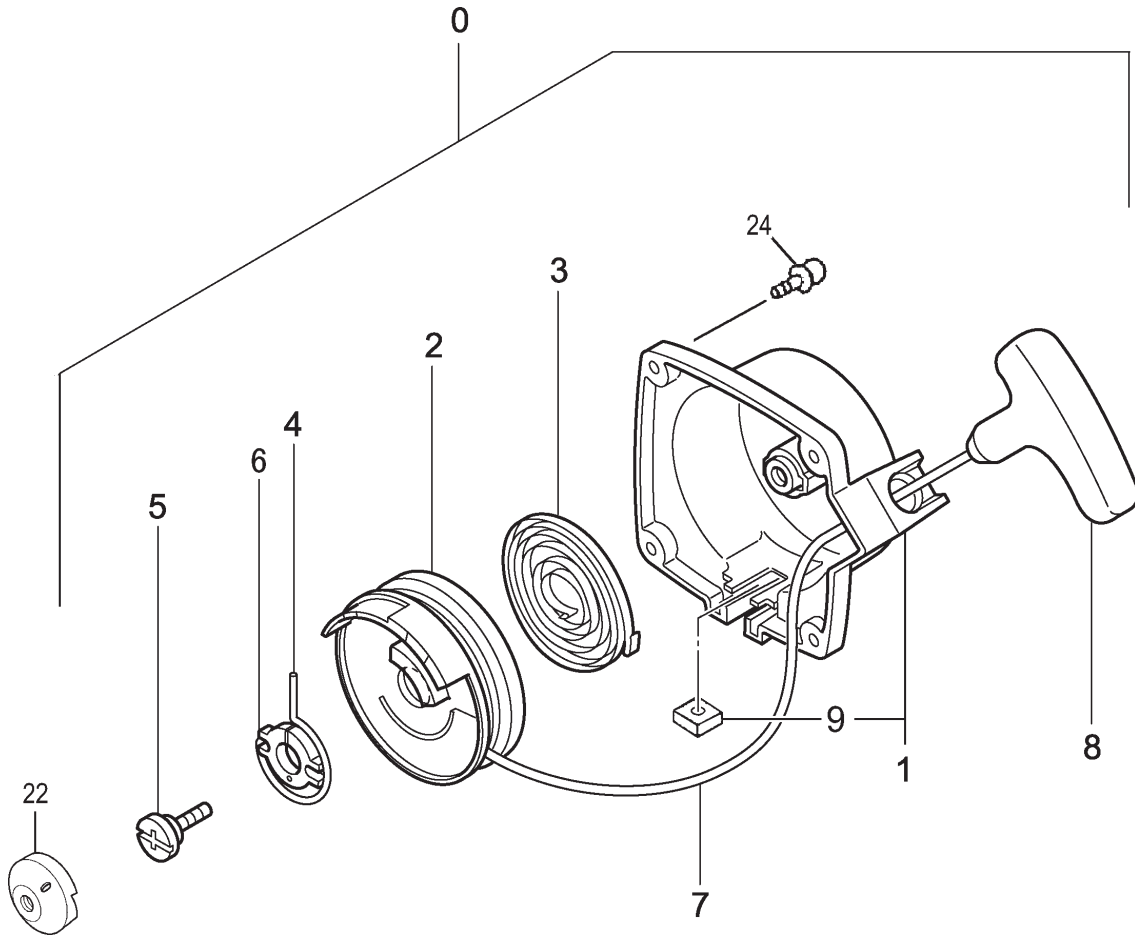

ITEM	PART NUMBER	DESCRIPTION	QTY	COMMENTS
5-0	7620304590	STARTER ASS'Y	1	
5-1	7720304580	BODY,STARTER	1	
5-2	7740304520	PULLEY,STARTER	1	
5-3	7790304520	SPRING,RECOIL	1	
5-4	7770304520	ARM,SWING	1	
5-5	8390304520	SCREW,SET	1	
5-6	7710304520	STAY,PULLEY	1	
5-7	7830304520	ROPE,STARTER	1	
5-8	7850304520	HANDLE,STARTER	1	
5-9	3153334020	NUT,SPECIAL 5MM	1	
5-22	7980304520	PULLEY,STARTER	1	
5-24	99464040185	BOLT,HEX,4x18WS	2	

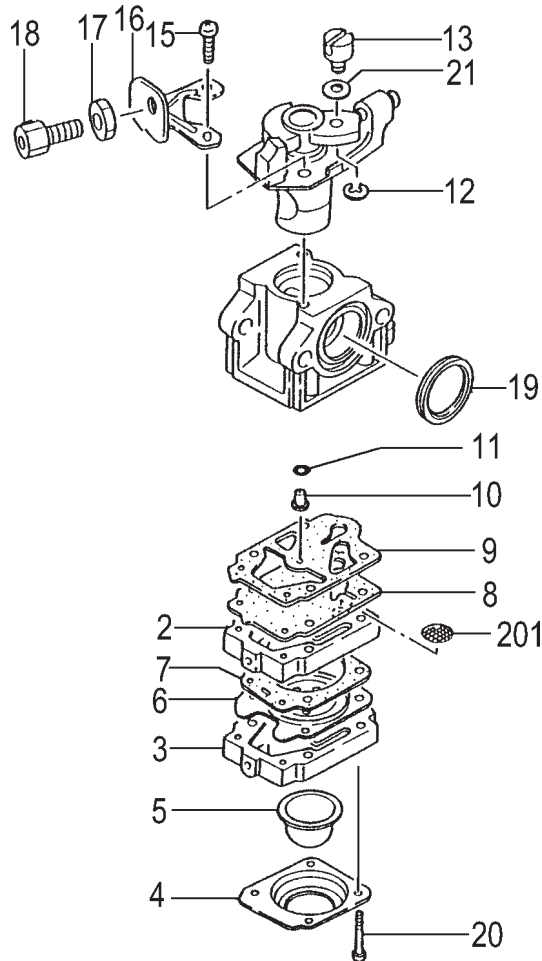

ITEM	PART NUMBER	DESCRIPTION	QTY	COMMENTS
	4550304590	CARBURETOR SET	1	Includes gasket
6-2	5752515380	BODY,PUMP	1	
6-3	4422515180	PUMP,PRIMING	1	
6-4	4762515120	COVER,DIAPHRAGM	1	
6-5	44725108200	BULB,PRIMING	1	
6-6	~ ~ ~	METERING DIAPHRAGM	1	~ Contained in Carb Repair Kit
6-7	~ ~ ~	GASKET,DIAPHRAGM	1	P/N 650-25124-900
6-8	~ ~ ~	DIAPHRAGM,PUMP	1	(not available individually)
6-9	~ ~ ~	GASKET,PUMP	1	
6-10	5992001W38	JET,MAIN LONG #38	1	
6-11	55025100200	O-RING	1	
6-12	48925100200	RING,STOP	1	
6-13	53925120200	SWIVEL	1	
6-15	51425100200	SCREW,THROTTLE SET	2	
6-16	54425164200	STAY,ADJUST,CABLE	1	
6-17	99101060013	NUT,6	1	
6-18	61425137200	ADJUSTER,CABLE	1	
6-19	4310634C200	GASKET,CLEANER	1	
6-20	5482515120	SCREW,SET	4	
6-21	5492516520	WASHER,THRUST	1	
6-201	57825007200	SCREEN,INLET	1	

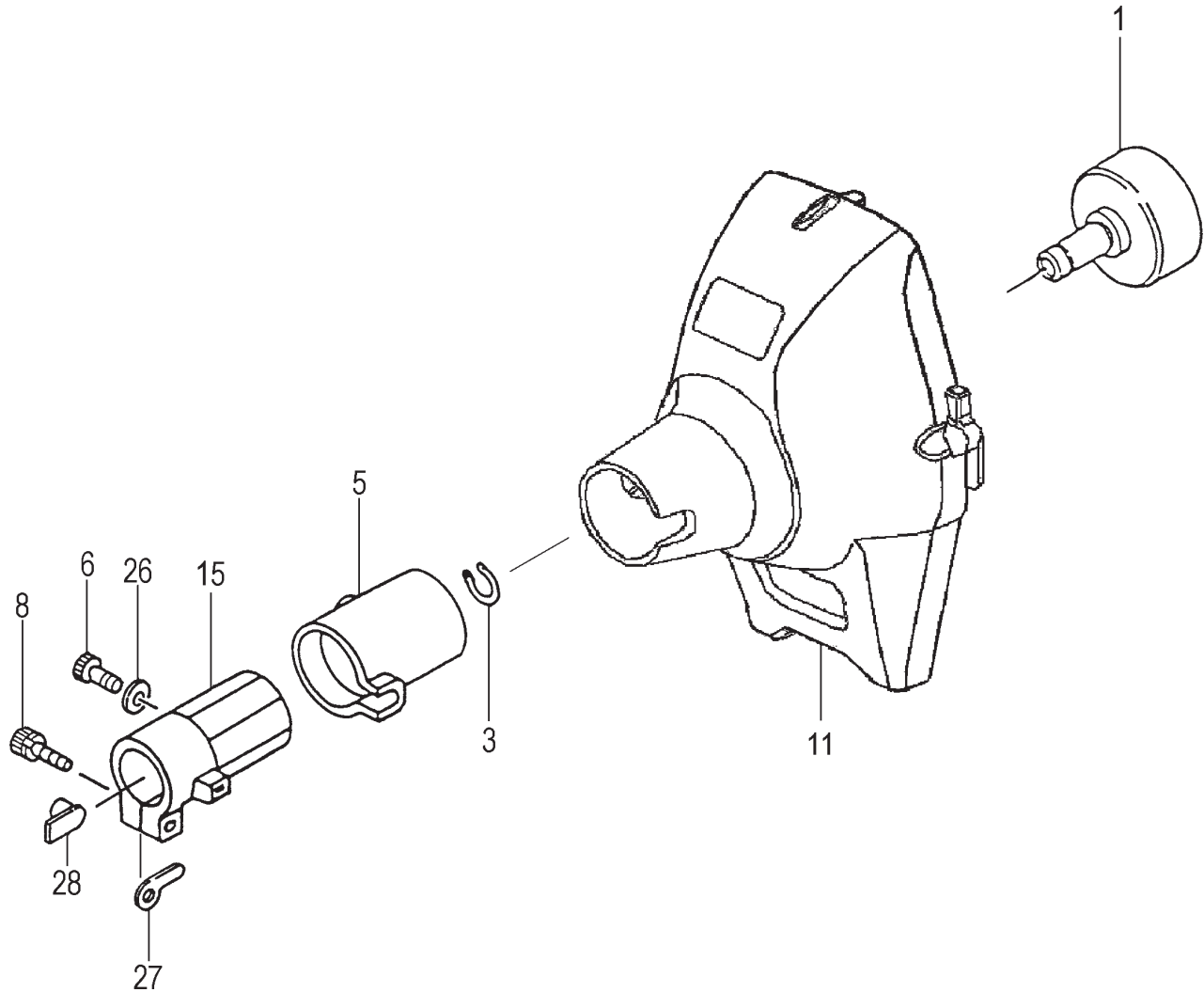

ITEM	PART NUMBER	DESCRIPTION	QTY	COMMENTS
7-1	2890707880	DRUM,CLUTCH,23mm	1	
7-3	99350012002	RING,STOP,C-12 EX	1	
7-5	5990098021	CUSHION,RUBBER	1	
7-6	99051050163	BOLT,HEX,5X16	1	
7-8	99461050254	BOLT,HEX HOLE,5X25S	1	
7-11	1120304580	CASE,FAN	1	
7-15	3600099620	PIPE HOLDER	1	
7-26	99201050061	WASHER,5	1	
7-27	3243735020	WASHER,GEAR CASE	1	
7-28	3610099020	FITTING,METAL	1	

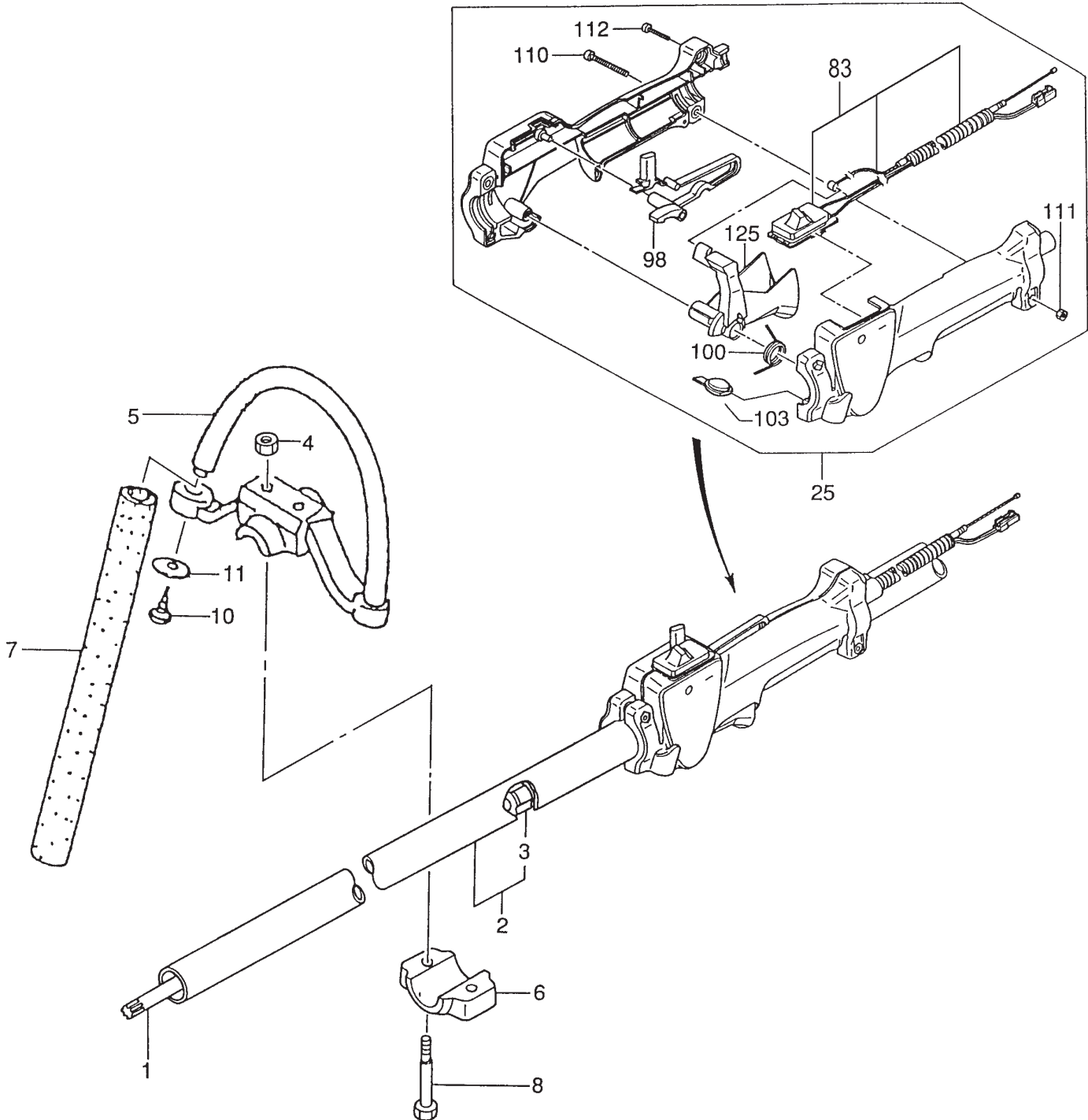

ITEM	PART NUMBER	DESCRIPTION	QTY	COMMENTS
8-1	3433761820	SHAFT,DRIVE,1483mm	1	
8-2	3413762382	PIPE,SHAFT,24x1450x1.6	1	
8-3	3473730090	BUSHING ASSY	5	
8-4	99101060041	NUT,6	2	
8-5	5003728620	HANDLE	1	
8-6	50637300200	BRACKET,HANDLE,A	1	
8-7	5033738E20	GRIP,HANDLE	1	
8-8	99423060432	BOLT,6X43	2	
8-10	99311052012	SCREW,TAPPING 5X20	1	
8-11	36832350200	WASHER,BRAKE SHAFT	1	
8-25	8703840290	LEVER,THROTTLE ASS'Y	1	
8-83	8853840080	WIRE,THROTTLE W/SWITCH	1	
8-98	2533840020	LEVER,SAFETY	1	
8-100	8323840020	SPRING,RETURN	1	
8-103	3223840020	GROMMET	1	
8-110	99431050203	SCREW 5X20	2	
8-111	99101050043	NUT,5	2	
8-112	9934604020	SCREW,4X20	4	
8-125	8803840020	LEVER,THROTTLE	1	

**Units Before Serial
Number Z170300**



ITEM	PART NUMBER	DESCRIPTION	QTY	COMMENTS
9-1	3003228021	CASE,GEAR,A	1	Units before s/n Z170300
9-2	99961690101	BEARING,BALL,#6901ZZ	1	
9-3	99961690101	BEARING,BALL,#6901ZZ	1	
9-4	99352012002	RING,STOP,S12,OUTER	1	
9-5	99351024002	RING,STOP,C-24,IN	1	
9-6	99961608004	BEARING,BALL,608DD	1	
9-8	30032250801	FITTING,GREASE	3	
9-9	99967041000	O-RING,P-41	1	
9-10	99413060101	SCREW,PLUS,6x10P	1	
9-11	99051050103	BOLT,HEX.HOLE,5X10	1	
9-12	99461050224	BOLT,HEX HOLE 5x22/S	1	
9-13	99144080022	NUT,FLANGE 8	2	
9-14	0273180020	WASHER	2	
9-15	3013228620	CASE,GEAR B	1	
9-16	99961600014	BEARING,BALL,#6000DD	1	
9-17	99351026002	RING,STOP,IN,C-26	1	
9-19	99355060000	RING,STOP,E6	1	
9-20	3273228020	COVER,GEAR CASE A	1	
9-22	99011040081	SCREW,4X8	2	
9-23	99961608004	BEARING,BALL,608DD	1	
9-25	5123228580	KNOB,HANDLE	1	
9-26	0333228081	GUIDE,SLIDE	1	
9-27	1963228520	BOLT,SPECIAL	1	
9-28	99210060062	WASHER,S,6	2	
9-29	99053060153	BOLT,HEX,6X15	2	
9-35	3023228200	SET,GEAR & PINION	1	
9-36	5123229820	KNOB,HANDLE	1	
9-37	3053228222	SHAFT,GEAR	1	
9-38	3813228920	NUT,SPECIAL	1	
9-40	0713228221	SHIM	1	
9-40	0713228222	SHIM	1	
9-40	0713228223	SHIM	1	
9-41	0963228920	COLLAR,26.8	1	
9-44	0863228620	SEAL,GREASE,B	1	
9-45	12132530200	NUT,CLAMP,BAR	1	
9-46	7603228220	WASHER,1.6	1	
9-47	99431060081	SCREW,6X8	1	

**Units After Serial
Number Z170301**

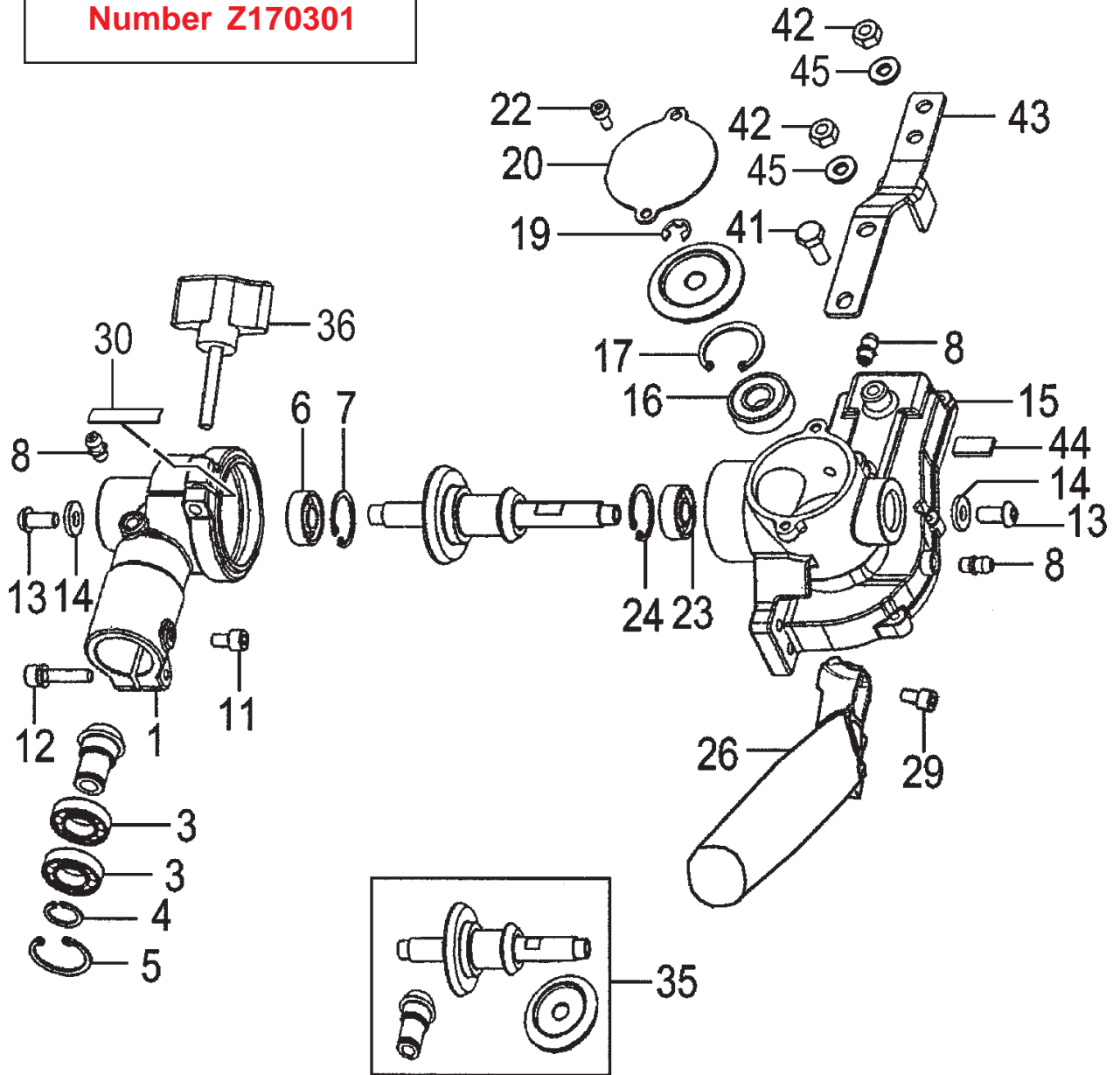

ITEM	PART NUMBER	DESCRIPTION	QTY	COMMENTS
10-1	3003228721	CASE,GEAR,A,24mm	1	Units after s/n Z170301
10-3	99961690101	BEARING,BALL,#6901ZZ	2	
10-4	99352012002	RING,STOP,S12,OUTER	1	
10-5	99351024002	RING,STOP,C-24,IN	1	
10-6	99961608004	BEARING,BALL,608DD	1	
10-7	99351022002	RING,STOP,C22,IN	1	
10-8	30032250801	FITTING,GREASE	3	
10-11	99051050103	BOLT,HEX.HOLE,5X10	1	
10-12	99461050254	BOLT,HEX HOLE,5X25S	1	
10-13	99053060125	SCREW,HEX HOLE 6X12	2	
10-14	87132600200	WASHER,SPECIAL,B	2	
10-15	3013228620	CASE,GEAR B	1	
10-16	99961600014	BEARING,BALL,#6000DD	1	
10-17	99351026002	RING,STOP,IN,C-26	1	
10-19	99355060000	RING,STOP,E6	1	
10-20	3273228020	COVER,GEAR CASE A	1	
10-22	99051040085	BOLT,HEX,4x8	2	
10-23	99961608004	BEARING,BALL,608DD	1	
10-24	99351022002	RING,STOP,C22,IN	1	
10-26	2103228620	HANDLE	1	
10-29	99053060153	BOLT,HEX,6X15	2	
10-30	0883228720	SEAL,D	1	
10-35	3023228600	GEAR & PINION SET	1	
10-36	5123228680	KNOB,HANDLE,A	1	
10-41	99023060141	BOLT,PLUS,6X14	1	
10-42	99101060041	NUT,6	1	
10-43	4623228620	PLATE,SUPPORT	1	
10-44	0863228620	SEAL,GREASE,B	1	

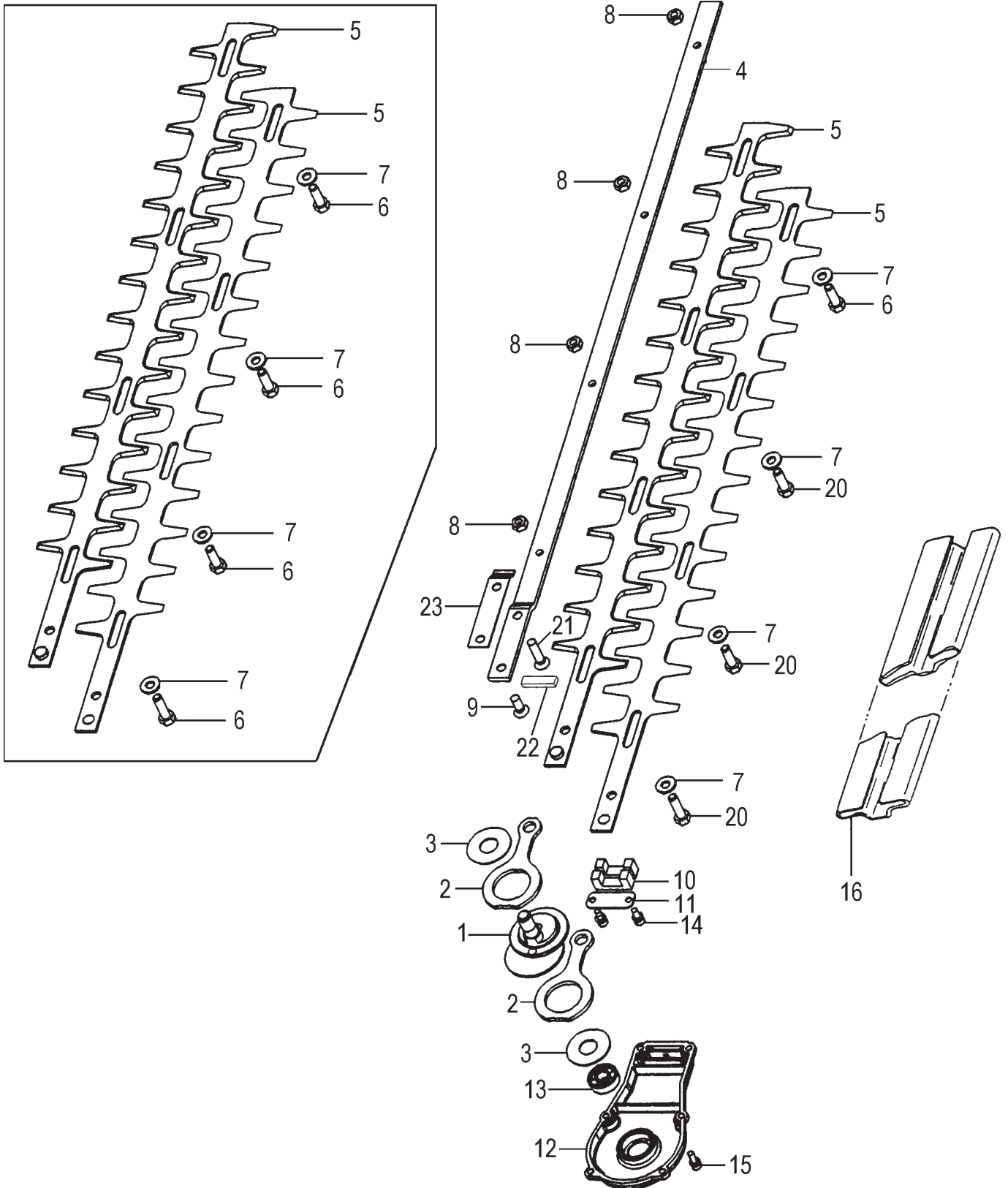

ITEM	PART NUMBER	DESCRIPTION	QTY	COMMENTS
11-1	1003228280	SHAFT,CAM	1	
11-2	1013316022	ROD,CAM	2	
11-3	0753228020	PLATE,GUIDE	2	
11-4	1223316021	BAR,24-5/8"OAL,STANDARD	1	~Z170300
11-4	1223228721	BAR,24-5/8"OAL,METRIC	1	~A325600
11-4	1223228621	BAR,24-5/8"OAL,METRIC	1	A325601~
11-5	1203228721	BLADE,A,DS,22"	2	
11-6	1243320221	BOLT,CUTTER FIXING,A	4	~A325600
11-6	1243228720	BOLT,FIXING,A,M6	1	A325601~
11-7	12933202201	WASHER,7	4	
11-8	1233317A20	NUT,SPECIAL	4	~A325600
11-8	40927	NUT,FLANGE,6	4	A325601~
11-9	99052060165	BOLT,HEX,6X16	2	~Z170300
11-9	99052060165	BOLT,HEX,6X16	1	Z170301~
11-10	08533160200	SEAL,GREASE A	2	~Z170300
11-10	0853228620	SEAL,GREASE,A	2	Z170301~
11-11	1053228020	HOLDING,PLATE	1	
11-12	3283228022	COVER,GEAR CASE	1	
11-13	99961608004	BEARING,BALL,608DD	1	
11-14	99461040104	BOLT,HEX,4X10,S	2	
11-15	99461040124	BOLT,HEX,4X12	6	
11-16	13833160200	COVER,CUTTER,22"	1	~Z170300
11-16	1383316820	COVER,CUTTER,22"	1	Z170301~
11-20	1253228720	BOLT,CUTTER FIXING,B	3	A325601~
11-21	99052060255	BOLT,HEX FLUSH,6X25	1	Z170301~
11-22	0873228620	SEAL,C	1	Z170301~
11-23	2963228620	SPACER	1	Z170301~

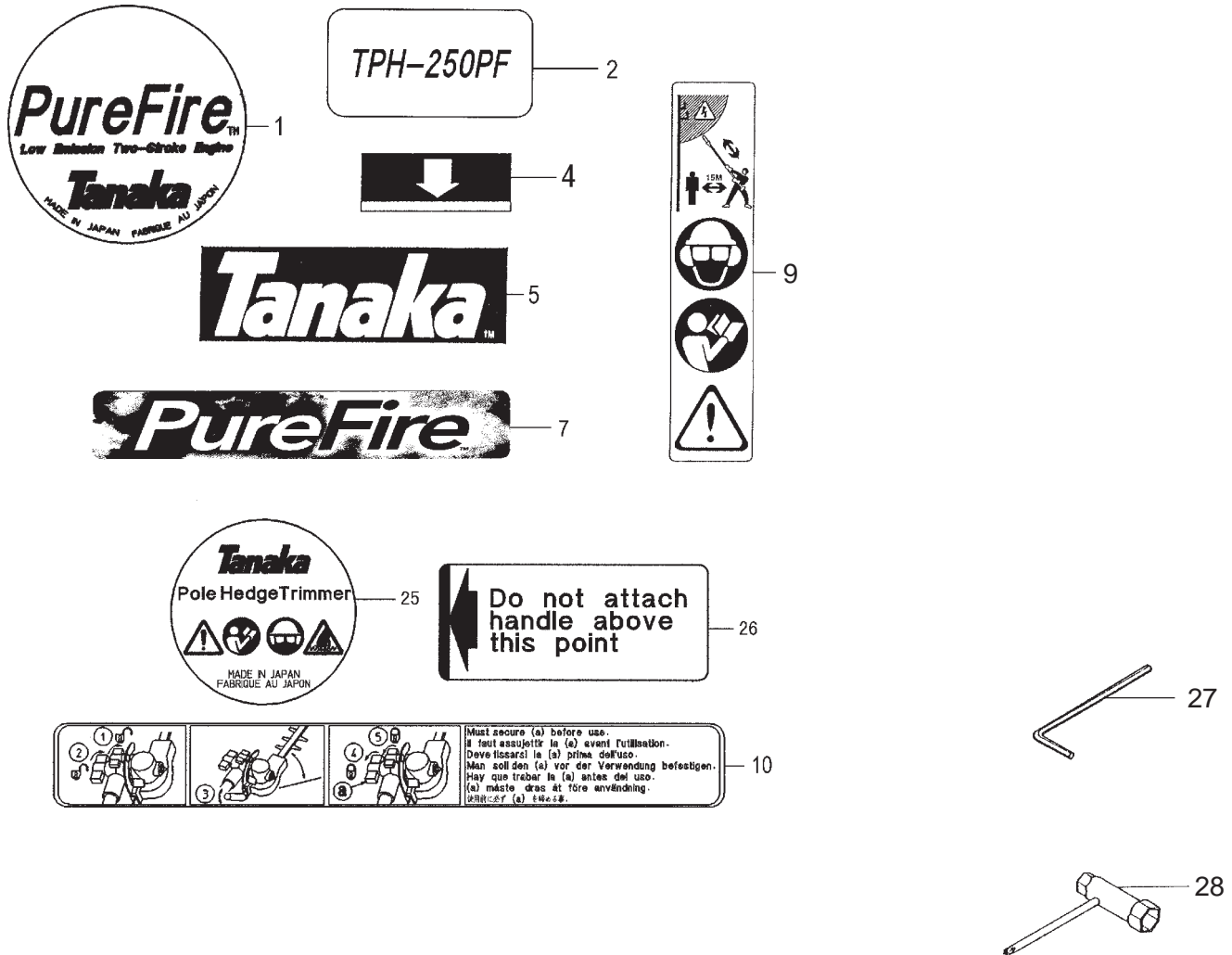

ITEM	PART NUMBER	DESCRIPTION	QTY	COMMENTS
12-1	9060304520	DECAL	1	
12-2	9064227020	DECAL,TPH-250PF	1	
12-4	92337400200	DECAL	1	
12-5	91505015200	DECAL,SYMBOL	1	
12-7	9293810020	DECAL,SYMBOL,PF	1	
12-9	9073230420	DECAL	1	
12-10	9203228521	DECAL,CAUTION B	1	~Z170300
12-25	9193229020	DECAL,A	1	
12-26	9233738F20	DECAL,LEVEL	1	
12-27	81320000200	WRENCH,HEX,4	1	
12-28	03629331501	SPANNER,COMBI	1	